

3 4 5 6 7 8 9 10 11 12 13 14 15 16 17 18

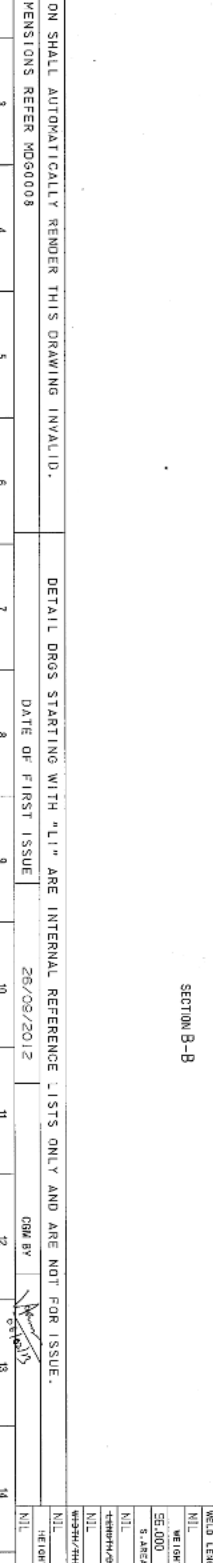
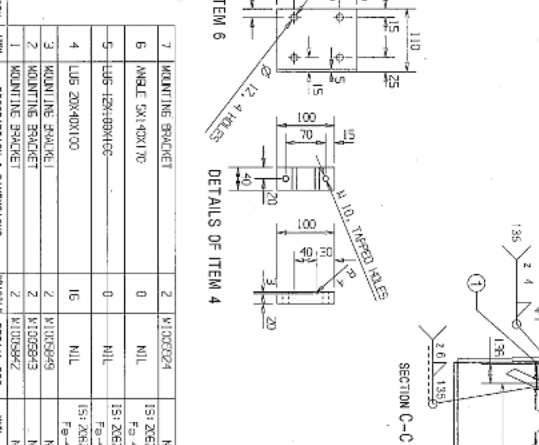
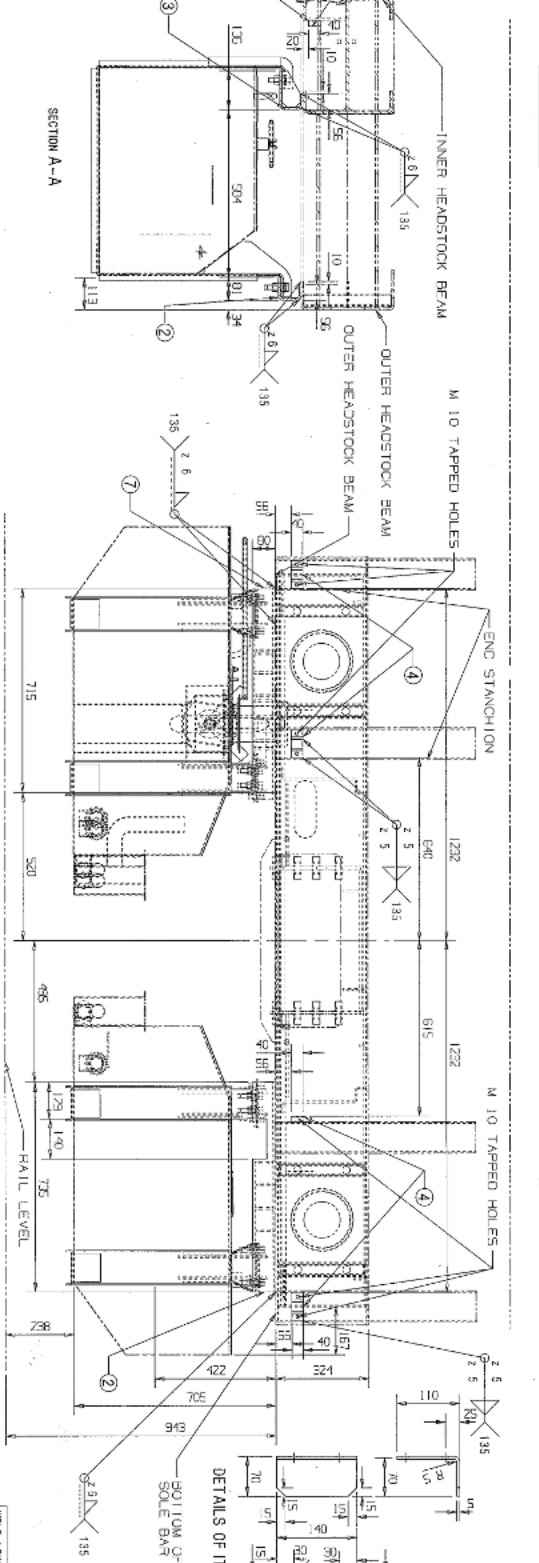
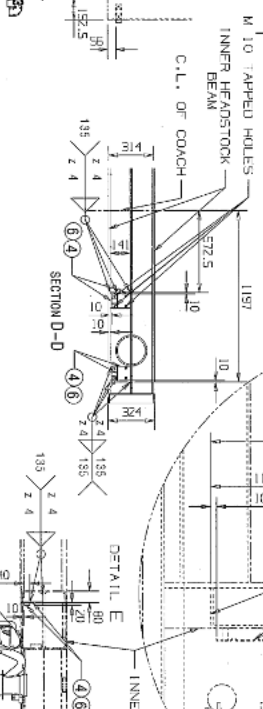
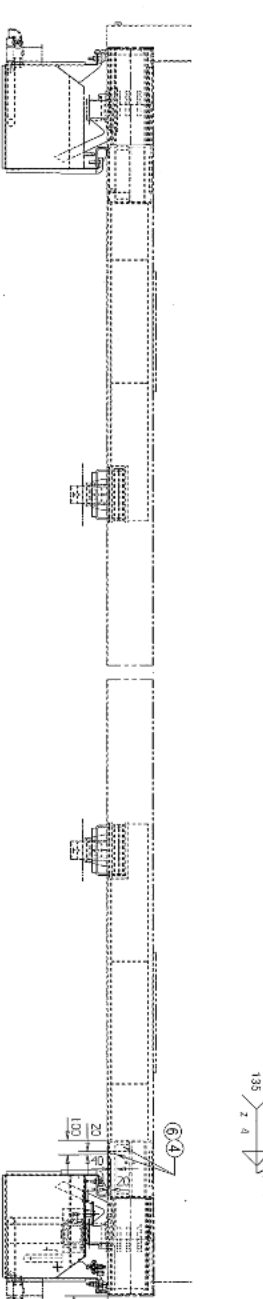
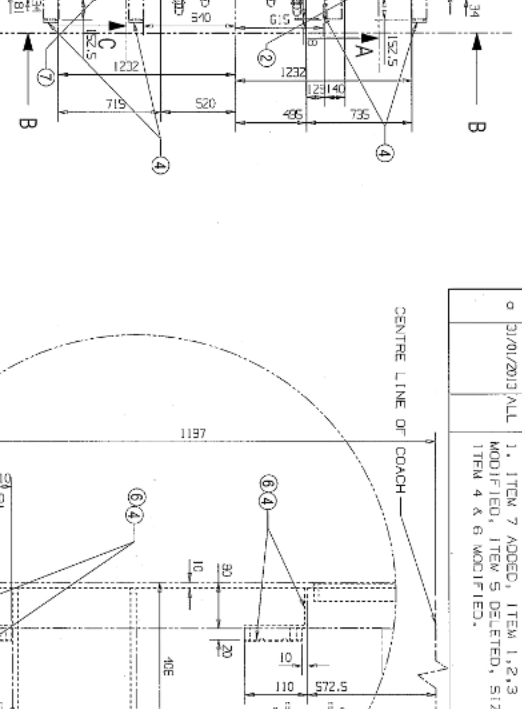
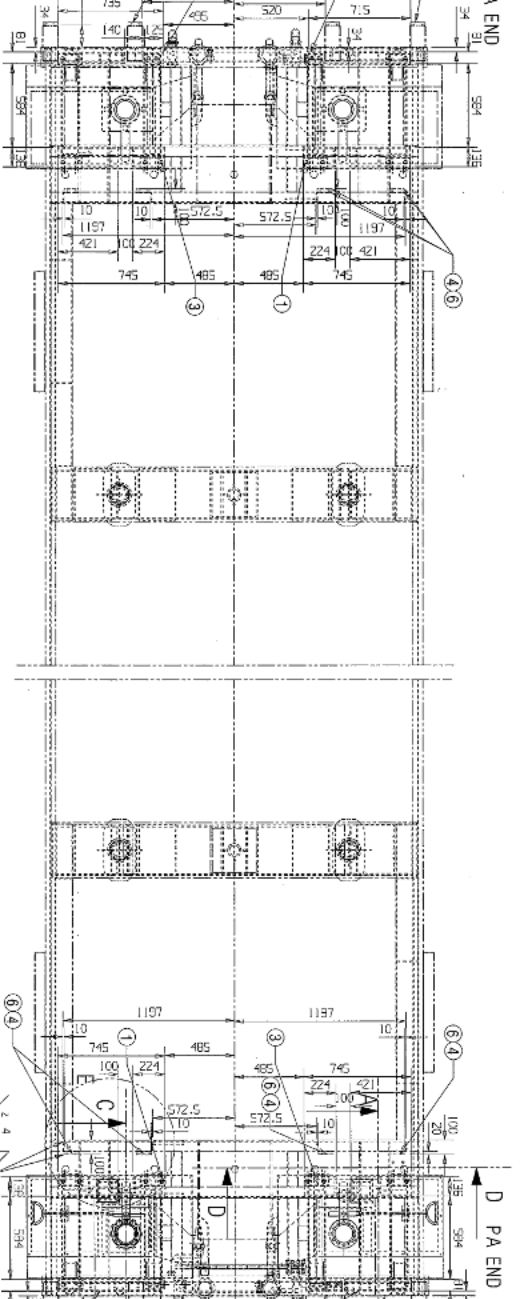

REV.	DATE	BY	CHKD.	DESCRIPTION
0	31/01/2013	ALL		1. ITEM 7 ADDED, ITEM 1, 2, 3 MODIFIED, ITEM 5 DELETED, SIZE OF ITEM 4 & 6 MODIFIED.

ITEM NO.	DESCRIPTION	QTY	UNIT	ITEM CODE	REVISION
1	MOUNTING BRACKET	2	NIL	K1000924	
2	SOLE BARS	2	NIL	K1000925	
3	MOUNTING BRACKET	2	NIL	K1000926	
4	MOUNTING BRACKET	2	NIL	K1000927	
5	MOUNTING BRACKET	2	NIL	K1000928	
6	MOUNTING BRACKET	2	NIL	K1000929	
7	MOUNTING BRACKET	2	NIL	K1000930	

DRG. NO. M100051
PL. NO. NIL
SCALE: SEE REVISIONS
DATE OF FIRST ISSUE: 26/05/2012
DATE OF LAST ISSUE: 31/01/2013

NO.	REVISION	DATE
1	ISSUED FOR MANUFACTURE	26/05/2012

DRG. NO. M100051
PL. NO. NIL
SCALE: SEE REVISIONS
DATE OF FIRST ISSUE: 26/05/2012
DATE OF LAST ISSUE: 31/01/2013

077129