

DIRECT INVITATION OF TENDERS

SMM-D(ELS) ITARSI WEST CENTRAL RAILWAY invites Tenders to the supply of the following item due for opening in this Office on 19-06-2014 at 14:00 PM .

The attention of Tenderers drawn to to the fact that they should clearly indicate in their Quotations, the origin, Maker's name Brand etc. of the material offered by them without which their quotations are liable to be rejected. They should only quote for the "UNIT" mentioned in the Tender List , otherwise their Quotations will not be considered.

Separate Quotations should be submitted for each item, otherwise their Quotations will not be considered.

The Tenders should be dropped in the Tender Box placed for this purpose in this office ( SMM-D(ELS) WEST CENTRAL RAILWAY ) only and not in the office of the Controller of Stores, Bombay ,C.S.T. which please

- 1). As List attached , Drawing & Sample can be seen in the office.
- 2). Firm to submit a copy of valid ITCC alongwith the quotations and put Rubber stamp of their sales tax registration no. on Quotation with Gaurantee that Brand/Make of material will be supplied in original pack.
- 3). 100% payment in advance will not be considered.
- 4). Payment after delivery against Receipt Note.
- 5). Inspection by Consignee / SMM-D(ELS) ITARSI

*he*

स.म.म. (इ.स.ए.स.) इटारसी  
SMM-D(ELS) ITARSI  
S.M.M.(ELS) ITARSI

स.म.म. (इ.स.ए.स.) इटारसी  
S.M.M.(ELS) ITARSI

Sr No	Tender No	PL No	Description	Quantity	Unit
1	70125315	25	Set of SS Elbow pipe for MPH to Radiator and Radiator to TFP, One set consisting 02 pipe in 02 Nos. (1) SS Elbow bellow small bend pipe Drg No.SL/5400/0015=01 No./Set. (2) SS Elbow bellow pipe MPH to Radiator Drg No.SL/5400/0014=01 No./Set.	2.000	SET/03
2	70135104	25	Set of locking Shim for alignment of MVMT/MVRH/MCP/CP .One set consisting of 12 items in 20 Nos .As per annexure attached	160.000	SET/03
3	70135196	23	Set of gasket for Transformer Consisting One set=(1) Item No 4= 01 No Item No 5=02 Nos Item No 6=01 No .Item No 7=02 Nos. As per Drg.No TACIA/25.(2) Item No 1=01 No . Item No.2=01 No. Item No.3=01 No. Item No. 7=02 Nos. Item No.11=03 Nos. Item No.13=01 no. Item No.14(a)=01 No..As per Drg.No ELW/BSL/2/F91/015, One Set 11 items=16 Nos. Material as per RDSO L No. EC/3.2.1 3 Phase dt 25.6.2007	60.000	SET/03
4	70135245	23	Dry chemical powder type fire extinguisher confirming to IS-2171 BIS with 120 Grams of CO2 gas cartridge, Sodium Bi Carbonate based powder and 500 mm delivery hose with ready nozzle complete with first charge, capacity 05 Kgs	30.000	NOS./01
5	70135279	23	Bus bar indicating lamp, model no BIS-RT 230V AC-R/Y/B or equal with LED Lamp for EOT crane electric panel.	10.000	NOS./01
6	70145045	00	Versalite powdered cleaner degreaser all metal safe powdered cleaner effective in removing of baked and charred oil grease shop soil and carbon, Packing size 01 Kgs.	20.000	KGS./13
7	70145065	00	Cartridge for FAX machine Canon make, Cartridge No.328 Starter.	2.000	NOS./01
8	70145070	23	Safety Cover for loco transformer auto winding As per Drg.No ET/TRS/SE/3/065.	7.000	NOS./01
9	70145071	23	Safety bracket for loco transformer As per Drg.No ET/TRS/E-5/3/066.	50.000	NOS./01
10	70145072	25	Safety cover for Pluse Generator , Drg.No ET/TRS/TR/4/045.	150.000	NOS./01
11	70145073	25	"Name plate of Master controller (MP) Consisting of 04 items- (1) F.O.R (2) TRACTION-BRAKING (3) 0-1-2-3-4 (4) +N-OP-N+, As per Drg.No 1TWD.241.115 item Sr No.13,14,15 &16".	100.000	SET/03
12	70145074	23	Electrically opeated Siren horizontal mounting, 03 phase,440V,50HZ,Audible range 05 Kms. Motor capacity 3.0HP,2850rpm,Kheraj model no. HDT-500, Make-Kheraj or Equal.	1.000	NOS./01



Sr No	Tender No	PL No	Description	Quantity	Unit
13	70145075	25	Self priming mono block sewage pump 3 phase, 50HZ, KW 3.7, HP 5.0 Suction dia= 80mm, delivery dia=80mm, head 16 Mtrs. Discharge- 486LPM, Impeller dia 224mm, Similar to Kirloskar make model No SP3LM+ Make Kirloskar.	3.000	NOS./01

  
S.M.M.(ELS) ITARSI  
S.M.M.(ELS) ITARSI

List of items against Pono 7013 5104-1. 65072dl-254113

(P27)

Vide Regn No. 573/0061

(P1)

Anneaux

16/03/13

Mr. Himanshu Kumar, etc.

Description

Set of locking shims. Each set consists of 12 items 20 nos as below -

- a) Shim 0.05 mm thick as per drg.no. NKJ/TRS/4/Aux/152  
Qty/set-02 nos./set.
- b) Shim 0.10 mm thick as per drg.no. NKJ/TRS/4/Aux/152  
Qty/set-02 nos./set.
- c) Shim 0.15 mm thick as per drg.no. NKJ/TRS/4/Aux/152  
Qty/set-02 nos./set.
- d) Shim 0.5 mm thick as per drg.no. NKJ/TRS/4/Aux/152  
Qty/set-02 nos./set.
- e) Shim 1.0 mm thick as per drg.no. NKJ/TRS/4/Aux/152  
Qty/set-01 nos./set.
- f) Shim 1.6 mm thick as per drg.no. NKJ/TRS/4/Aux/152  
Qty/set-01 nos./set.
- g) Shim 0.05 mm thick as per drg.no. BSL/TRS/WAM-4/SK/4/288  
Qty/set-02 nos./set.
- h) Shim 0.10 mm thick as per drg.no. BSL/TRS/WAM-4/SK/4/288  
Qty/set-02 nos./set.
- i) Shim 0.15 mm thick as per drg.no. BSL/TRS/WAM-4/SK/4/288  
Qty/set-02 nos./set.
- j) Shim 0.5 mm thick as per drg.no. BSL/TRS/WAM-4/SK/4/288  
Qty/set-02 nos./set.
- k) Shim 1.0 mm thick as per drg.no. BSL/TRS/WAM-4/SK/4/288  
Qty/set-01 nos./set.
- l) Shim 1.6 mm thick as per drg.no. BSL/TRS/WAM-4/SK/4/288  
Qty/set-01 nos./set.

21/3/13

ASCE/TRS/4/152  
सहा. म. वि. इन्जीनियर  
(क.स.प.) प.म.पेल, इटारसी  
ASCE (TR) W.C. Jy. Kani



वरि.सा.प्र. (इ.एल.एस.) इटारसी  
S.M.M.(ELS) ITARSI

SSE/E3A

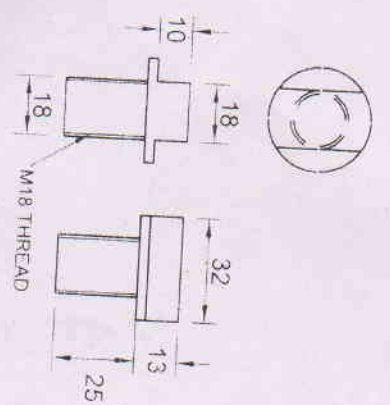
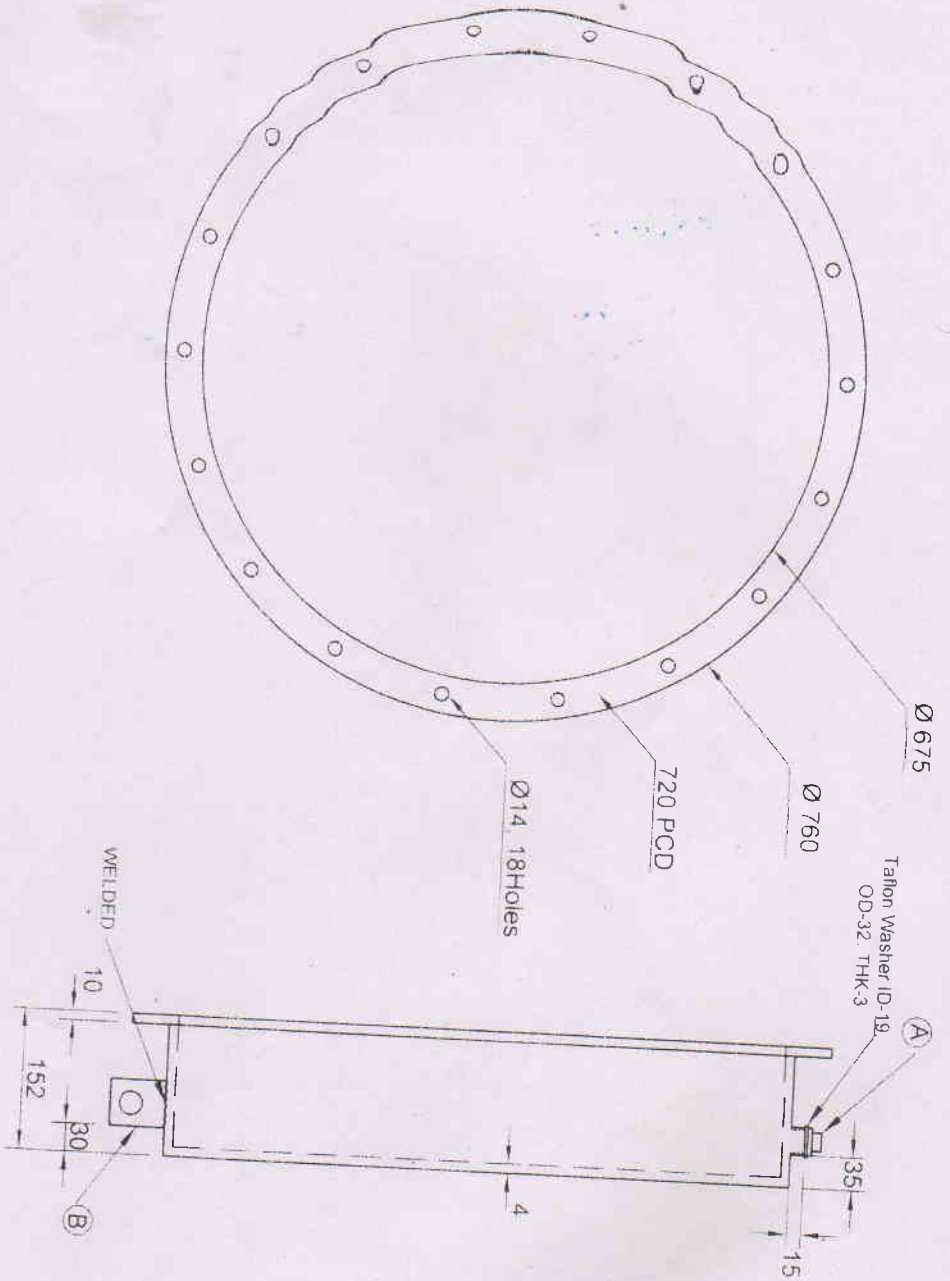

DETAIL-A' (DUMMY BOLT)

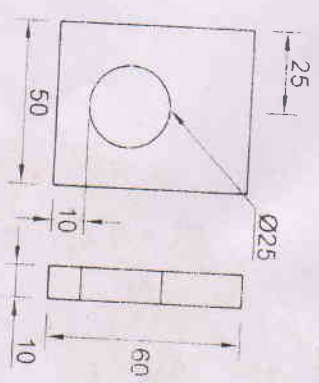



DETAIL-B' (LIFTING HOOK)

SI-092999

**टिप्पणी :-**

1. सभी माप मि.मी. में है।
2. मटेरियल एम आई एस . 1079 : 1973
3. डम्मी बोल्ट जीक प्लेटेड आई. एस. 1364
4. बहुमात्रा में उत्पादन करने से पूर्व एक नमूना कनसाईनी की स्वीकृती के लिए जॉच हेतु दिया जाये।

 वरि अनुभाग इन्की / इ-5-		संदर्भ :- दिये गये नमूने के अनुसार	<b>परिचय मध्य रेल</b> (अजय माथुर) म वि इंजीनियर क.च.स्टा वि.लो. शेड इट
		विवरण	
कनि इन्की (I) / ड्राइंग	आरेखित	लोको ट्रॉसफार्मर आटो वाइडिंग फॉर	
आरेखित	अनुपात	एन.टी.एस	
शेखर	अनुपात	आरेख क्र. ईटी / टी.आर.एस / एस.ई. / 3 / 065	

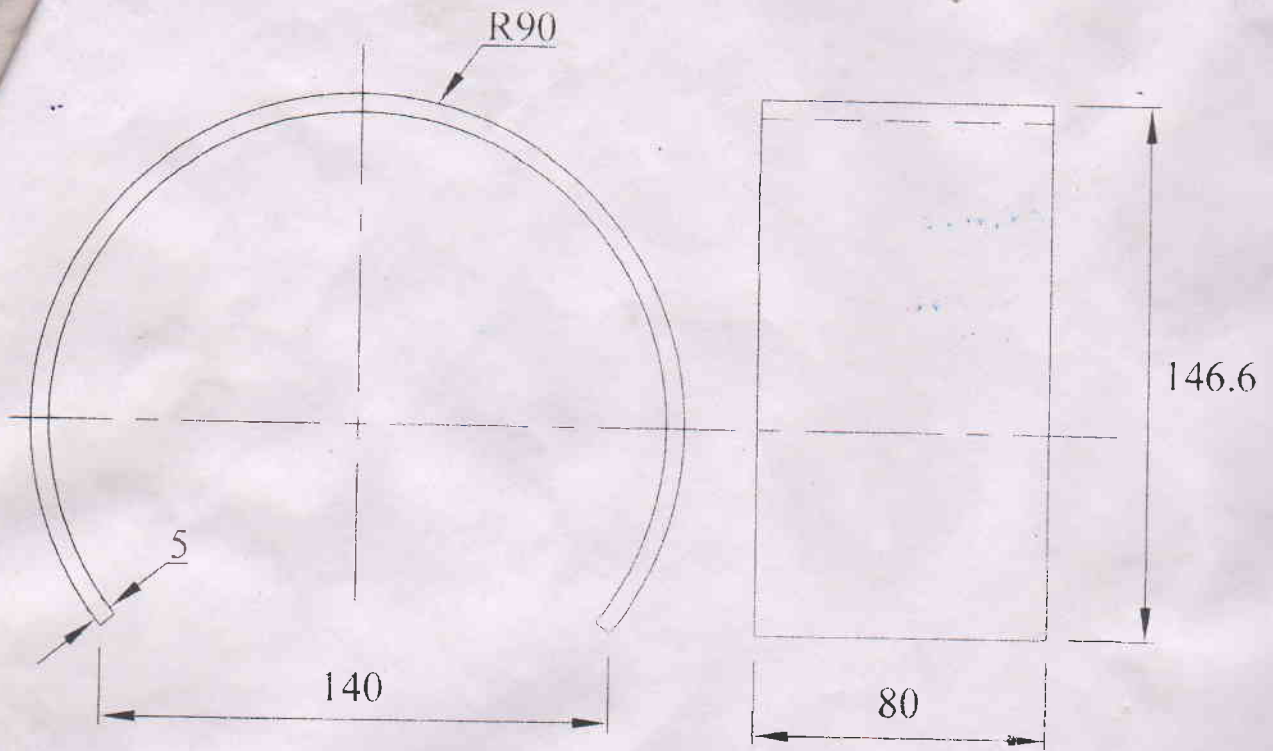

### टिप्पणी :-

1. सभी मापे मि.मी. में है।
2. मटेरियल एम.एस. प्लेट 5 मि.मी. मोटाई (IS:2062).
3. बहुमात्रा में उत्पादन करने से पहले, एक नमूना कनसाईनी की स्वीकृती के लिए, जॉच हेतु दिया जाये।

SI-09222

		हस्ता / दिनोंक	संदर्भ :- नमूने के अनुसार	पश्चिम मध्य रेल
अनुभाग इंजी / ई-4		24/7/10	विवरण	
कनि / इंजी / ड्राईंग		24/7/10	सेफटी कवर	/वरि. मं वि इंजीनियर क.च.स्टा वि.लो. शेड इटारसी
आरेखित		24.7.10	(पल्स जनरेटर के लिए)	