

ALT. NO.	ALT. DATE	ZONE	ALTERATIONS	AUTHORITY
NIL	NIL	NIL	NIL	NIL

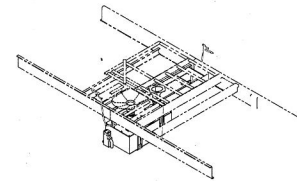

4789a
Entered
Date: 27 MAR 2014

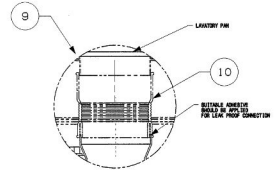
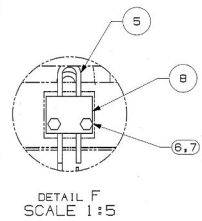
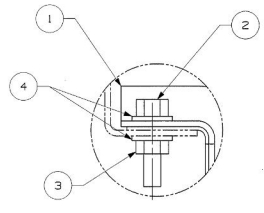
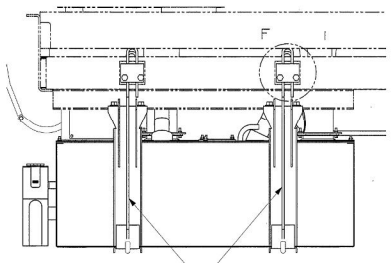
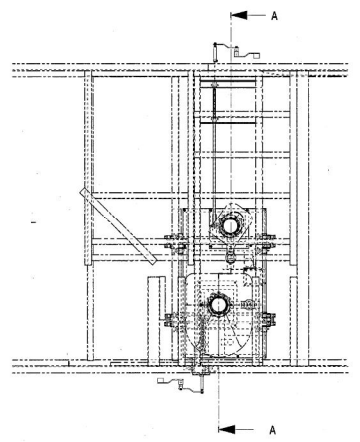
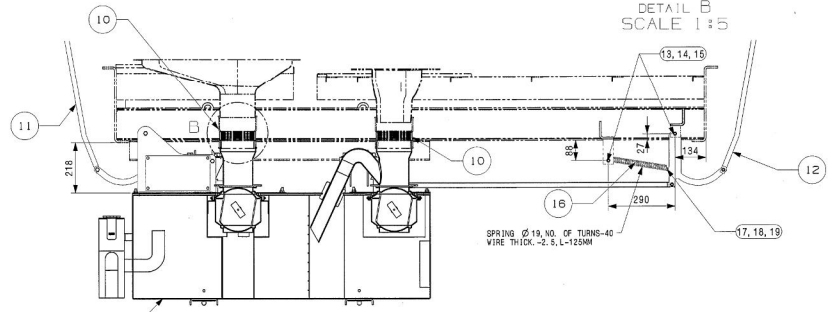
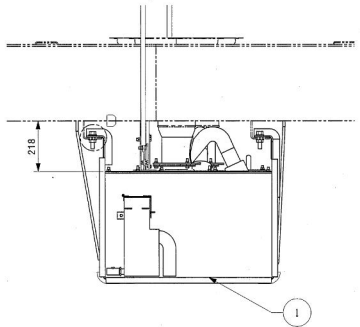

SECTION A-A

ITEM	DESCRIPTION & DIMENSIONS	QTY	GROUP	DETAIL DRG	MATL. & SPEC.	REMARKS
19	STAINLESS STEEL NYLOC NUT M6 (A2-70 TO IS4367 PT.14)	1	L1HWS00	IS: 7002-1991 DIN932	ITEM-7 COATING TO MTS 097	
18	STAINLESS STEEL MACHINE WASHER A5.4 (A2 TO IS4367 PT.14-1994)	1	L1HWS00	IS: 2016-1967 DIN125	ITEM-4	
17	STAINLESS STEEL HEX HEAD BOLT MEXIS (A2-70 TO IS4367 PT.14-94)	1	L1HWS01	IS: 1364 PT.1-52 CE	ITEM-1 COATING TO MTS 097	
16	SPRINGS	1	NIL	IS: 4454 PART-1 1981 GRADE-2	NIL	
15	NYLOC NUT M10	2	L1HW0B	IS: 7002-1991	ITEM-36 COATING TO MTS 097	
14	STAINLESS STEEL MACHINE WASHER A10.5 (A2 TO IS4367 PT.14-1994)	2	L1HWS00	IS: 2016-1967 DIN125	ITEM-6	
13	BUSH Ø 13X10, L=40	2	NIL	AISI-304	NIL	
12	OPENING MECHANISM (DISABLED LAV.)	1	M1006175	NIL	NIL	
11	OPENING MECHANISM	2	M1005966	NIL	*	
10	RUBBER CONNECTOR	2	M1005979	NIL	NIL	
9	CLAMP Ø 150MM	2	NIL	IS: 4762-94 AISI-304	NIL	
8	PLATE	4	CCB3115	NIL	NIL	
7	HEX HEAD SCREW M10X25	6	L1HW02	IS: 1364 PT.2-52 S.6.CE	ITEM-17 COATING TO MTS 097	
6	SPRING WASHER B10	6	L1HW09	IS: 3063-1994	ITEM-21 COATING TO MTS 097	
5	WIRE CABLE, Ø 8MM-7X7	2	NIL	DIN-3055 STAINLESS STEEL	L-3000	
4	SPRING WASHER B16	16	L1HW09	IS: 3063-1994	ITEM-23 COATING TO MTS 097	
3	STAINLESS STEEL NYLOC NUT M16 (A2-70 TO IS4367 PT.14)	6	NIL	IS: 7002-2005 (A2-70 TO IS4367 PT.14)	NIL	
2	STAINLESS STEEL HEX HEAD SCREW M16X60 (A2-70 TO IS4367 PT.14-94)	6	L1HWS02	IS: 1364 PT.2-52 ,CE	ITEM-26 COATING TO MTS 097	
1	DRPE BIO-DIGESTER SYSTEM	1	M1006103	NIL	NIL	

WELD LENGTH	ITEM	DESCRIPTION & DIMENSIONS	ASSEMBLY	DETAIL DRG	MATL. & SPEC.	REMARKS
NIL	M	LAV. & ITS FITTINGS	SUPERSEDED			
WEIGHT	GROUP	FILE	24\38\61\1\38\61\1\m1006102.dwg (1/30)			
S.AREA	MOUNTING OF DRPE BIO-DIGESTER					
NIL	SYSTEM IN CONV. DSLR					
NIL	RAIL COACH FACTORY, KAPURTHALA					
WIDTH/THICK.	रेल कोच फैक्टरी कपूरथला					
HEIGHT	IRS					
NIL	PL NO. NIL					
NIL	DRG.NO. M1006102					

THIS DRAWING IS THE INTELLECTUAL PROPERTY OF RAIL COACH FACTORY, KAPURTHALA. NO PART OF THIS DRAWING IS TO BE REPRODUCED OR TRANSMITTED IN ANY FORM OR BY ANY MEANS, ELECTRONIC OR MECHANICAL, WITHOUT PERMISSION FROM CHIEF DESIGN ENGINEER, RAIL COACH FACTORY, KAPURTHALA.

"JOINTLY DEVELOPED BY IR & DRDO"

ANY MANUAL ALTERATION SHALL AUTOMATICALLY RENDER THIS DRAWING INVALID. FOR UNTOLERANCED DIMENSIONS REFER MDG0008

DETAIL DRGS STARTING WITH "L1" ARE INTERNAL REFERENCE LISTS ONLY AND ARE NOT FOR ISSUE.

DATE OF FIRST ISSUE: 11/11/2013

CGM BY: [Signature]