

15	16	17	18	19
ALT. NO	ALT. DATE	ZONE	ALTERATIONS	AUTHORITY
NIL	NIL	NIL	NIL	NIL

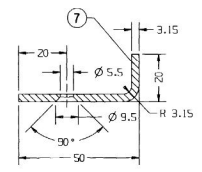
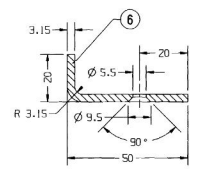
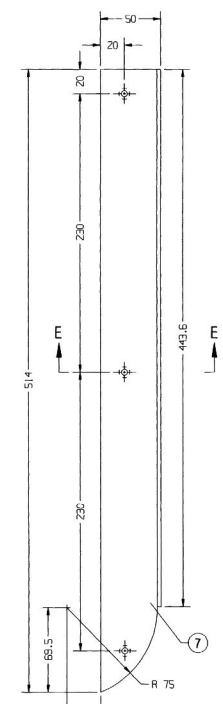
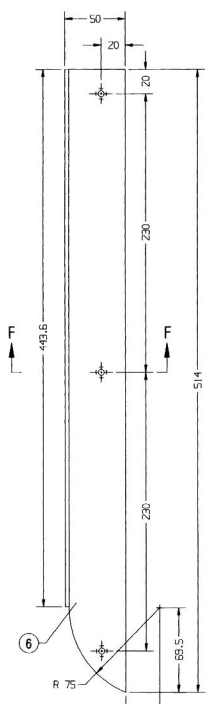
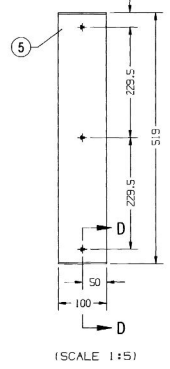
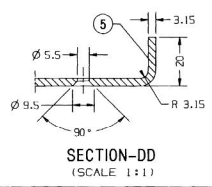
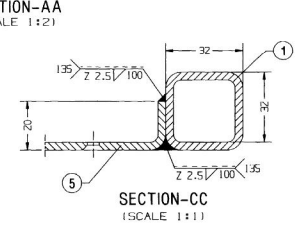
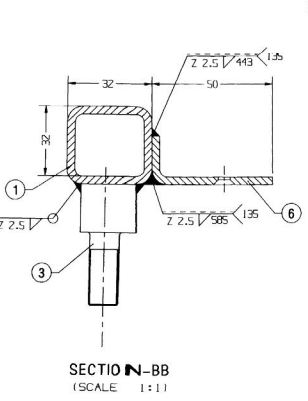
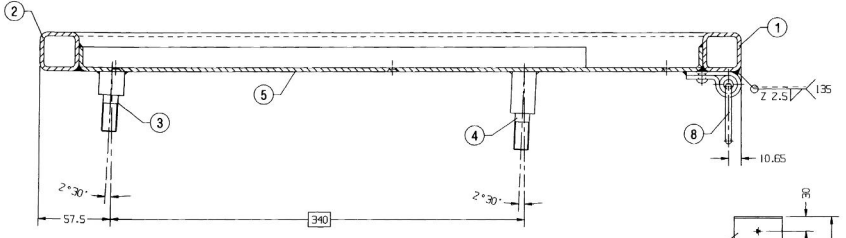
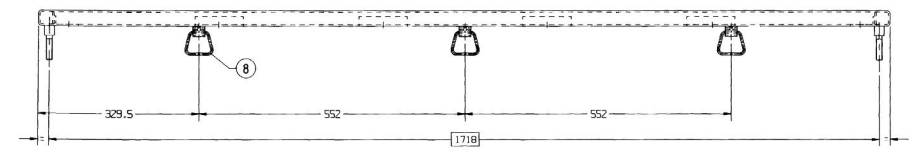
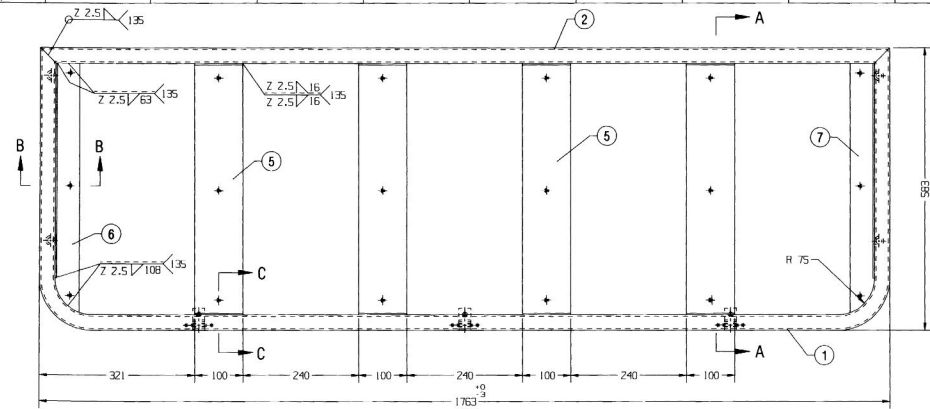

- NOTE:-
1. FRAME ASSEMBLY TO BE PAINTED WITH ONE COAT OF RED OXIDE ZINC CHROMATE 10 IS: 2074-52.
 2. IS: 4923-65, OF S45, YSt 240.
 3. ALL WELDS SHOULD BE GRIND.
 4. ALL SHARP CORNERS SHOULD BE ROUNDED OFF.
 5. DIMENSIONS MARKED □ THIS ARE TO BE MAINTAINED BY USE OF JIG.

ITEM	DESCRIPTION & DIMENSIONS	Q/PASSY	DETAIL DRG	MATL. & SPEC.	REMARKS
8	RING BELOW SEAT	3	SE61325	NIL	NIL
7	ANGLE STIFFENER (R.H.) 3.15X5X514	1	NIL	IS: 5986-92 Fe-300	NIL
6	ANGLE STIFFENER (L.H.) 3.15X5X514	1	NIL	IS: 5986-92 Fe-300	NIL
5	CHANNEL STIFFENER 3.15X100X54	4	NIL	IS: 5986-92 Fe-300	NIL
4	STUD	2	SE61379	NIL	NIL
3	STUD	2	SE61378	NIL	NIL
2	SO. TUBE 32X32X3.25 L-1763.00	1	L150701	IS: 4923-65 HF S45 YSt-240	ITEM-5
1	SO. TUBE 32X32X3.25 L-2925.00	1	L150701	IS: 4923-65 HF S45 YSt-240	ITEM-5

WELD LENGTH	ITEM	DESCRIPTION & DIMENSIONS	Q/PASSY	DETAIL DRG	MATL. & SPEC.	REMARKS
5.081	M	GROUP	SEATS & UPPER BERTHS	SUPERSIDES:	NIL	
WEIGHT	FILE	/users2/furnish/stbrth/se61362.prt				
21.200	KG	FRAME				SCALE: ASE/REC
S. AREA	FOR TRANSVERSE SEAT				1:5	DRN
LENGTH/DTH	RAIL COACH FACTORY, KAPURTHALA				REF: DRG	
WIDTH/THICK.	INDIAN RAILWAYS STANDARD				PL NO. 01139332	
HEIGHT	DRG. NO. SE61362					
NIL	M	DATE	22/04/2002			

ANY MANUAL ALTERATION SHALL AUTOMATICALLY RENDER THIS DRAWING INVALID. DETAIL DRGS STARTING WITH "LI" ARE INTERNAL REFERENCE LISTS ONLY AND ARE NOT FOR ISSUE.

FDR UNTOLERANCED DIMENSIONS REFER MDG0008

DATE OF FIRST ISSUE: 22/04/2002