

15	16	17	18	19
REVISION	DATE	BY	DESCRIPTION	AUTHORITY
NIL	NIL	NIL	NIL	NIL

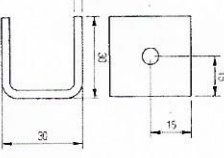
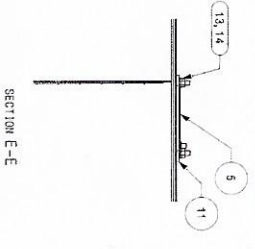
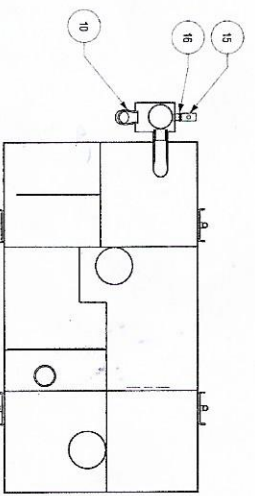
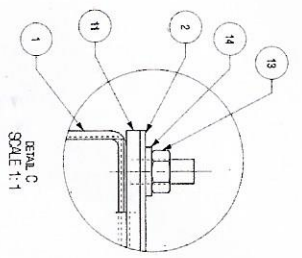
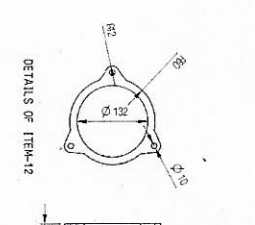
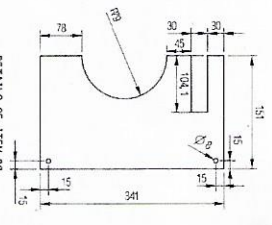
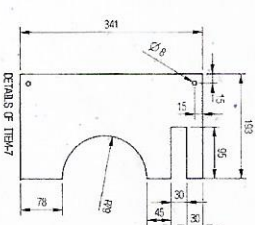
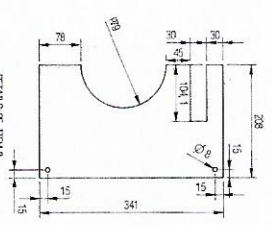
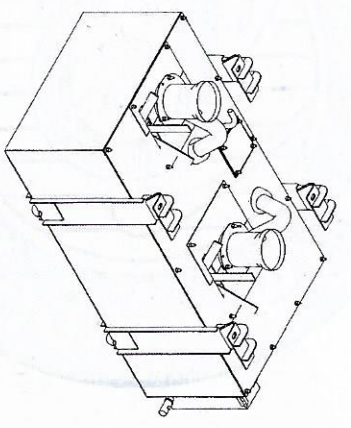
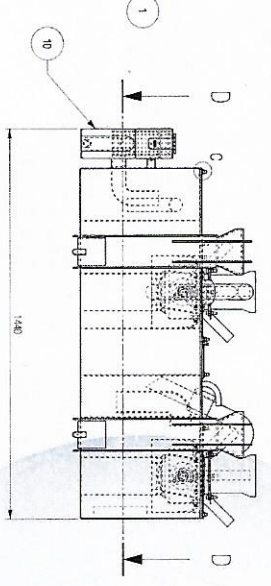
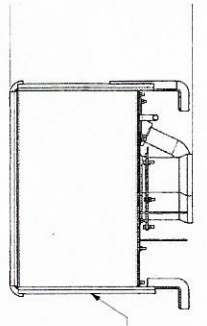
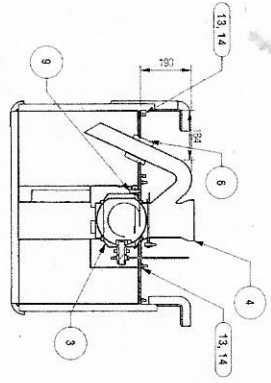
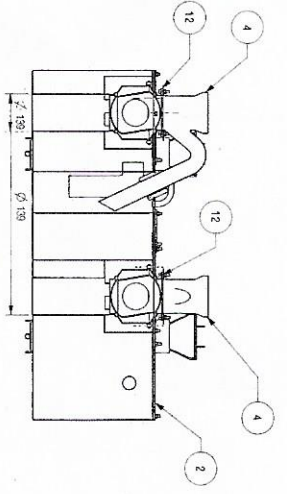
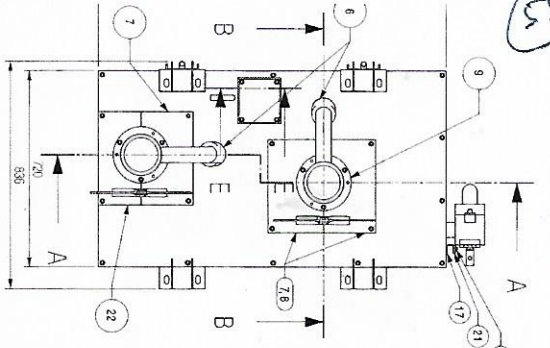

ITEM	DESCRIPTION & DIMENSIONS	QUANTITY	DETAIL	UNIT
22	COVER FOR BALL VALVE	1	AS1-316	NIL
21	RUBBER PACKING 5X30X20	1	NIL	NIL
20	SPRING WASHER B8	1	LHW09	ITEM-19
19	STAINLESS STEEL HEX NUT M8 (D=7.0 TO IS: 1387 P1-14)	1	IS: 1387 PT 3-92	ITEM-2
18	HEX HEAD BOLT M8X20	1	LHW01	ITEM-45
17	CHANNEL	1	NIL	NIL
16	HEX UNION 1"	1	AS1-316	NIL
15	BALL VALVE 1"	1	AS1-316	COMPERCIAL ITEM-20
14	SPRING WASHER B8	36	LHW09	ITEM-3
13	STAINLESS STEEL HEX NUT M8 (D=7.0 TO IS: 1387 P1-14)	36	IS: 1387 PT 3-92	ITEM-3
12	RUBBER PACKING 5X30X20	2	NIL	NIL
11	RUBBER SEAL 3X30X400	2	EPDM	NIL
10	O-RING NBR 1.5	1	MI003338	NIL
9	HEX HEAD BOLT M8X25	12	LHW01	ITEM-4
8	COVER FOR BALL VALVE	1	AS1-316	NIL
7	COVER FOR BALL VALVE	2	AS1-316	NIL
6	SEAL	2	MI003336	NIL
5	SHEET 2X150X160	1	NIL	NIL
4	P-TIEUP	2	MI003106	NIL
3	BALL VALVE Ø 125	2	CS-1039	NIL
2	TOP PLATE	1	MI006105	NIL
1	BIO-TANK	1	MI006104	NIL

JOINTLY DEVELOPED BY IR & DRDO

INTERNAL ALTERATION SHALL AUTOMATICALLY RENDER THIS DRAWING INVALID. DETAIL DRES ST

DATE OF FIRST ISSUE: 13/07/2014

FOR CONV. DSLR

DRDO BIO-DIGESTER SYSTEM

RAJ COACH FACTORY, KANURTHALA

IRS

DRG.NO./M0006103

27 MAR 2014

W.C.R.